

TECHNICAL DOCUMENTATION



- PAG 1 **RIPIANI / SHELVING**
- PAG 7 **CABINET CON SERRATURA / LOCKABLE CABINETS**
- PAG 8 **PANNELLO OTTICA / PANEL FOR EYEGLASSES**
- PAG 9 **SUPPORTI PER RIPIANI e PANNELLI / SUPPORTING ELEMENTS FOR SHELVES and PANELS**
- PAG 11 **MONTANTI VERTICALI / VERTICAL POLES**
- PAG 13 **ELEMENTI APPENDERIA / HANGING ELEMENTS**
- PAG 14 **ILLUMINAZIONE / LIGHTING**
- PAG 15 **ESEMPI / EXAMPLES**

RIPIANI / SHELVING

cod. CRPM60 -- / Code CRPM60 --

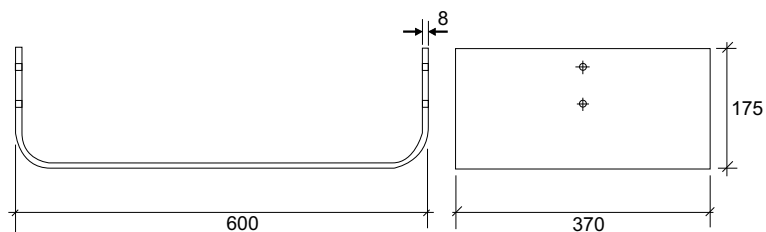
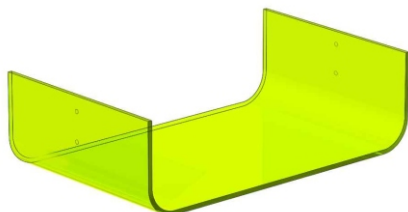

CODE	DESCRIPTION	DIMENSIONS LxLxH mm	WEIGHT kg	MATERIAL	COLOUR
CRPM60TR	Mensola curvata a forma di "U"/ <i>U-shaped curved shelf</i>	600 x 370 x 175	3,26	PMMA	Trasparente/ <i>Transparent</i>
CRPM60VD					Acquamarina/ <i>Aquamarine</i>
CRPM60AR					Arancio fluo/ <i>Fluo orange</i>
CRPM60AZ					Blu/ <i>Blue</i>
CRPM60GV					Giallo fluo/ <i>Fluo yellow</i>
CRPM60RD					Rosso fluo/ <i>Fluo red</i>
CRPM60BI					Bianco/ <i>White</i>
CRPM60WF					Satinato/ <i>Frosted</i>

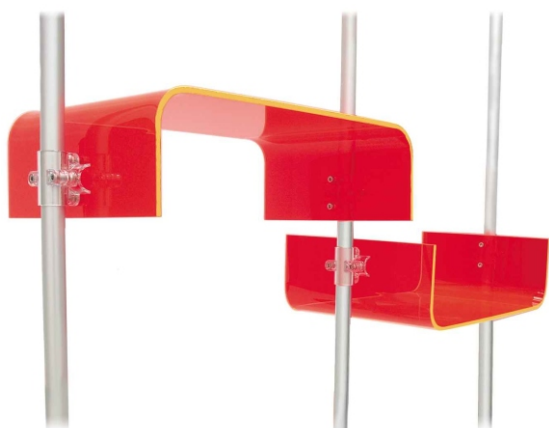

INSTALLAZIONE INDIPENDENTE
INDEPENDENT INSTALLATION

INSTALLAZIONE IN PARALLELO
PARALLEL INSTALLATION

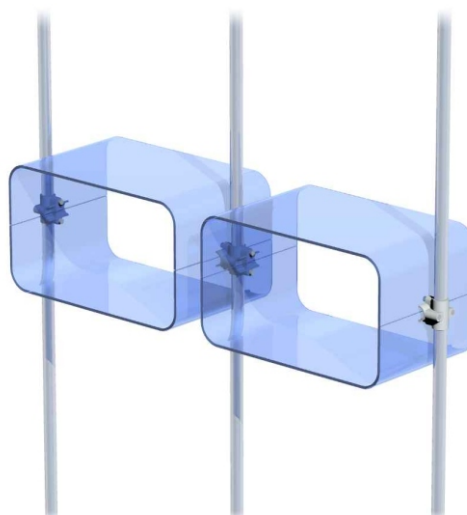

● **INSTALLAZIONE / INSTALLATION**

Per poter installare le mensole cod CRPM60 sui tubi verticali è necessario utilizzare gli appositi attacchi. Tali attacchi possono essere di due tipi, a seconda che le mensole vengano installate in modo "indipendente" (sfalsate) o "in parallelo"

In order to install shelves code CRPM60 on the vertical poles, you will need specific clamping. Clamps come in two different models, depending on which kind of installation you are going to choose: "independent" installation or "parallel" installation.

● **MENSOLA SINGOLA / SINGLE SHELF**

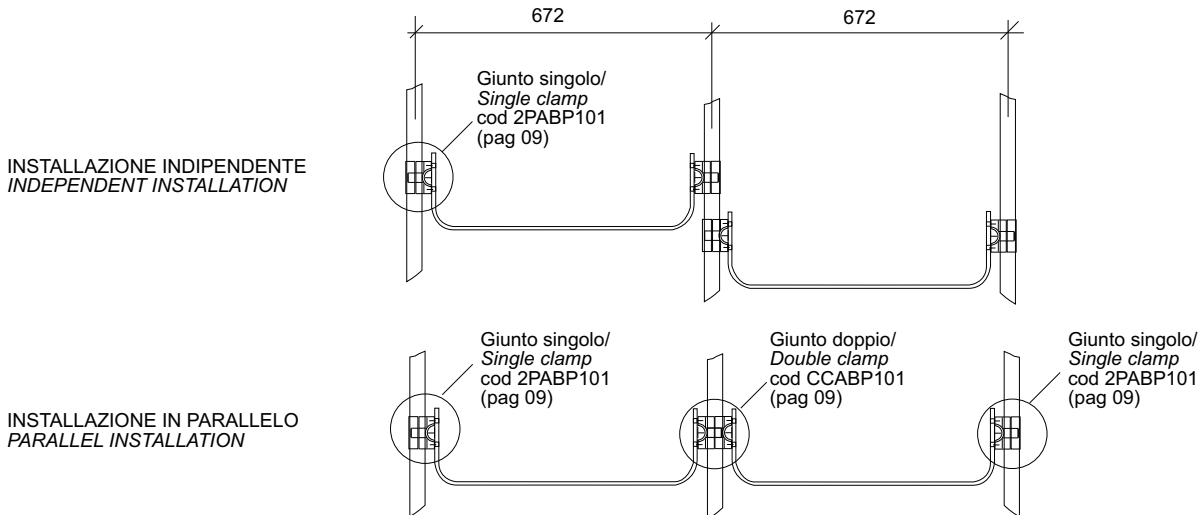

ATTENZIONE: Nel caso di installazione "in parallelo", sarà necessario utilizzare, all'inizio e alla fine della serie, un giunto "singolo" cod 2PABP101, mentre su tutti i montanti intermedi verranno utilizzati giunti "doppi" cod CCABP101
IMPORTANT NOTE: When making a "parallel" installation, you will always need, at the beginning /at the end of the series, a "single" clamp code 2PABP101, while on all the middle poles you will use the "double" clamps code CCABP101

● **MENSOLA DOPPIA (una capovolta sull'altra) / DOUBLE SHELVES (one upturned)**

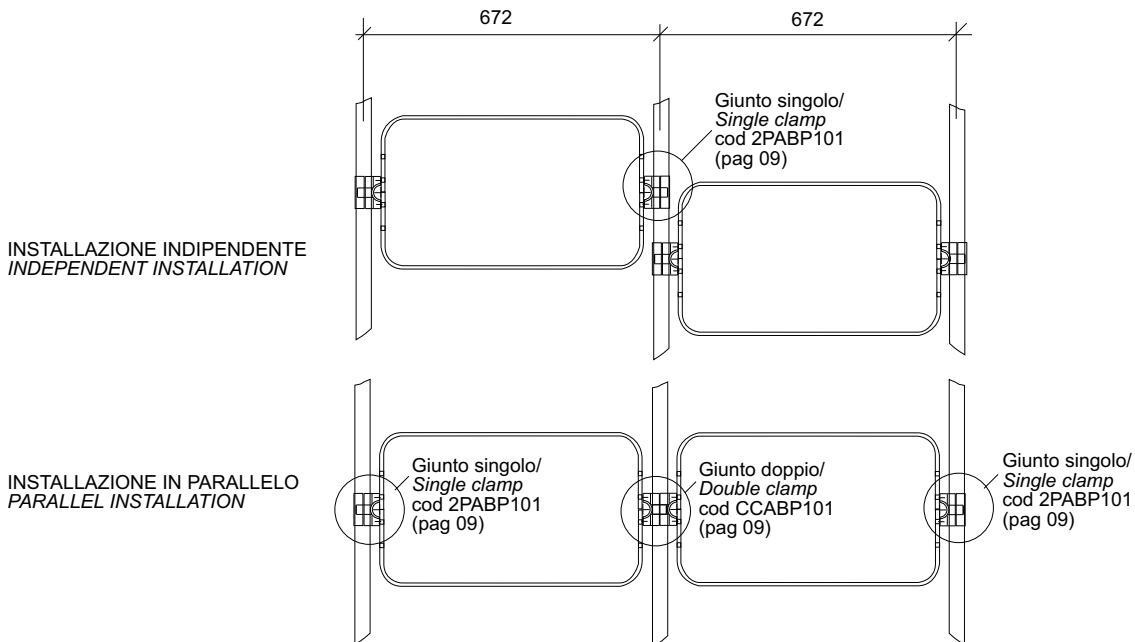

ATTENZIONE: Nel caso di installazione "in parallelo", sarà necessario utilizzare, all'inizio e alla fine della serie, un giunto "singolo" cod 2PABP101, mentre su tutti i montanti intermedi verranno utilizzati giunti "doppi" cod CCABP101
IMPORTANT NOTE: When making a "parallel" installation, you will always need, at the beginning /at the end of the series, a "single" clamp code 2PABP101, while on all the middle poles you will use the "double" clamps code CCABP101

RIPIANI / SHELVING

cod. RPPM62 -- / Code RPPM62 --

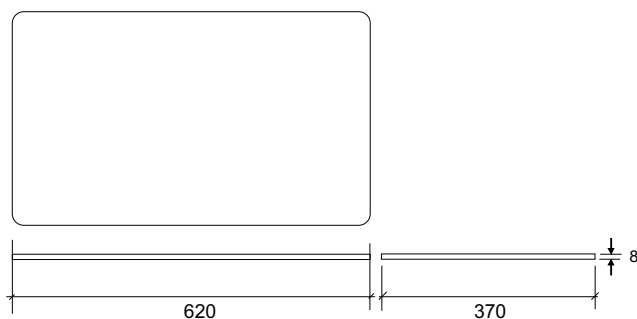
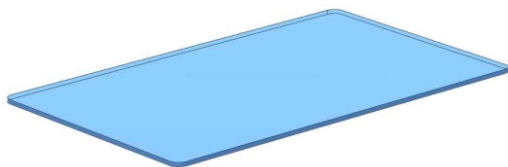

CODE	DESCRIPTION	DIMENSIONS LxH mm	WEIGHT kg	MATERIAL	COLOUR
RPPM62TR	Ripiano orizzontale/ Horizontal shelf	620 x 370 x 8	2,10	PMMA	Trasparente/Transparent
RPPM62VD					Acquamarina/Aquamarine
RPPM62AR					Arancio fluo/Fluo orange
RPPM62AZ					Blu/Blue
RPPM62GV					Giallo fluo/Fluo yellow
RPPM62RD					Rosso fluo/Fluo red
RPPM62BI					Bianco/White
RPPM62WF					Satinato/Frosted

● INSTALLAZIONE / INSTALLATION

Per poter installare le mensole cod RPPM62 sui tubi verticali è necessario utilizzare gli appositi attacchi (cod DBMRP101)

In order to install shelves code RPPM62 on the vertical poles, you will need the specific clamps (code DBMRP101)

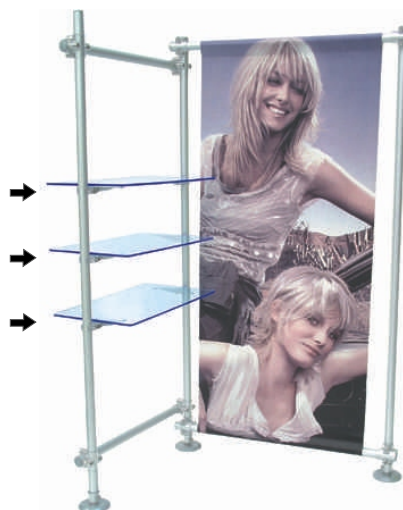
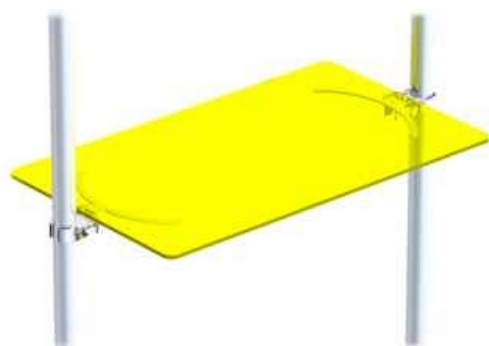
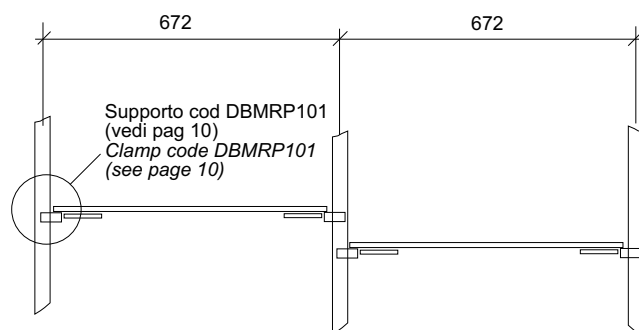

RIPIANI / SHELVING

cod. DK3PM3 -- / Code DK3PM3 --

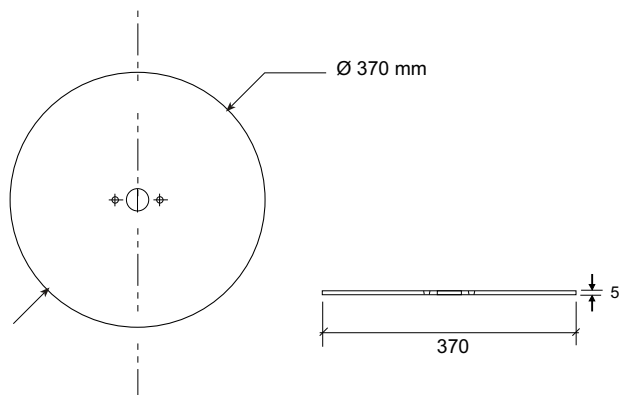

CODE	DESCRIPTION	DIMENSIONS LxLxH mm	WEIGHT kg	MATERIAL	COLOUR
DK3PM3TR	Ripiano circolare con foro centrale passante, completo di attacco per fissaggio al montante verticale/ Round shelf with central hole, fixing element to vertical pole included	Ø 370 x 5	1,15	PMMA	Trasparente/Transparent
DK3PM3VD					Acquamarina/Aquamarine
DK3PM3AR					Arancio fluo/Fluo orange
DK3PM3AZ					Blu/Blue
DK3PM3GV					Giallo fluo/Fluo yellow
DK3PM3RD					Rosso fluo/Fluo red
DK3PM3BI					Bianco/White
DK3PM3WF					Satinato/Frosted

● INSTALLAZIONE / INSTALLATION

Il ripiano circolare cod. DK3PM3 è completo di attacco per fissaggio al montante verticale

Round shelf code DK3PM3 includes fixing element to vertical pole

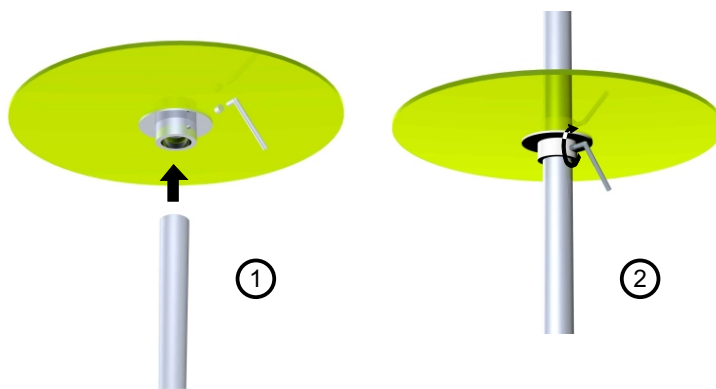
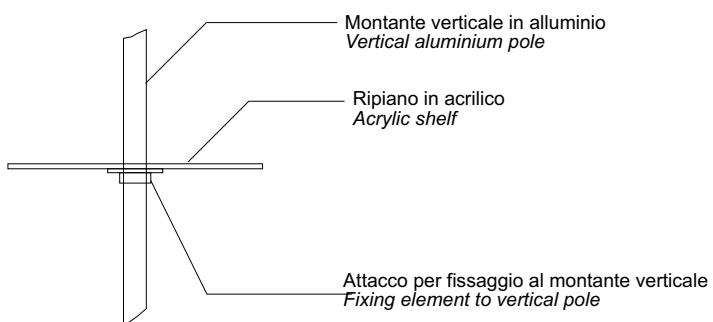

RIPIANI / SHELVING

cod. DK1PM1 -- / Code DK1PM1 --

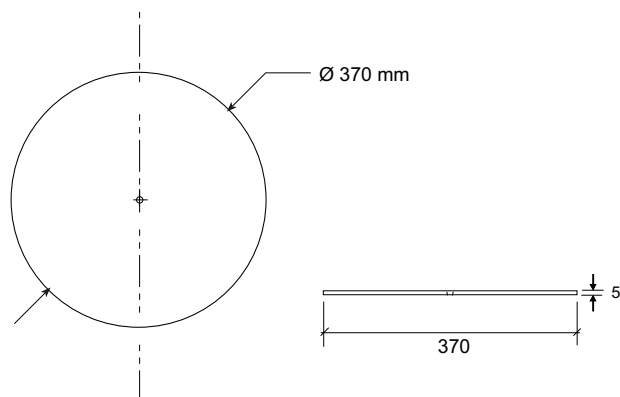

CODE	DESCRIPTION	DIMENSIONS LxLxH mm	WEIGHT kg	MATERIAL	COLOUR
DK1PM1TR	Ripiano circolare, completo di braccio e attacco per fissaggio "a sbalzo" su montante verticale/ <i>Round shelf, arm and overhanging connection on vertical pole included</i>	Ø 370 x 5	1,05	PMMA	Trasparente/ <i>Transparent</i>
DK1PM1VD					Acquamarina/ <i>Aquamarine</i>
DK1PM1AR					Arancio fluo/ <i>Fluo orange</i>
DK1PM1AZ					Blu/ <i>Blue</i>
DK1PM1GV					Giallo fluo/ <i>Fluo yellow</i>
DK1PM1RD					Rosso fluo/ <i>Fluo red</i>
DK1PM1BI					Bianco/ <i>White</i>
DK1PM1WF					Satinato/ <i>Frosted</i>

● INSTALLAZIONE / INSTALLATION

Il ripiano circolare cod. DK1PM1 è completo di braccio e attacco per fissaggio al montante verticale

Round shelf code DK1PM1 includes arm and overhanging connection on vertical pole

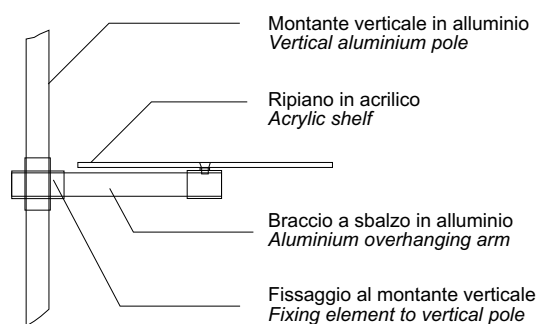

RIPIANI / SHELVING

cod. RPPM32 -- / Code RPPM32 --

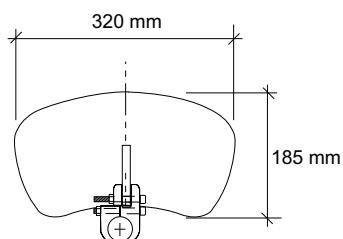
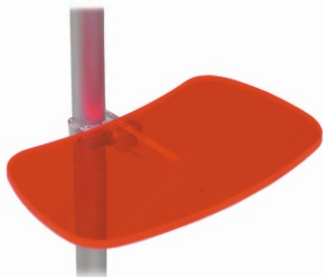

CODE	DESCRIPTION	DIMENSIONS LxLxH mm	WEIGHT kg	MATERIAL	COLOUR
RPPM32TR	Ripiano sagomato, completo di attacco per fissaggio su montante verticale. Specifico per calzature/ <i>Shaped shelf, fixing element to vertical pole included. Specific for footwear.</i>	320 x 185 x 8	0,47	PMMA	Trasparente/ <i>Transparent</i>
RPPM32VD					Acquamarina/ <i>Aquamarine</i>
RPPM32AR					Arancio fluo/ <i>Fluo orange</i>
RPPM32AZ					Blu/ <i>Blue</i>
RPPM32GV					Giallo fluo/ <i>Fluo yellow</i>
RPPM32RD					Rosso fluo/ <i>Fluo red</i>
RPPM32BI					Bianco/ <i>White</i>
RPPM32WF					Satinato/ <i>Frosted</i>

● INSTALLAZIONE / INSTALLATION

Il ripiano circolare cod. RPPM32 è completo di attacco per fissaggio al montante verticale

Round shelf code RPPM32 includes fixing element to vertical pole

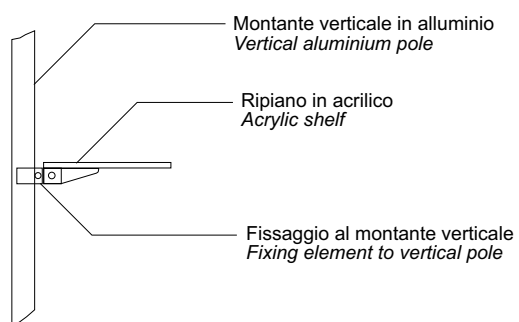

CABINET CON SERRATURA / LOCKABLE CABINETS

cod. FLBX60 -- / Code FLBX60 --

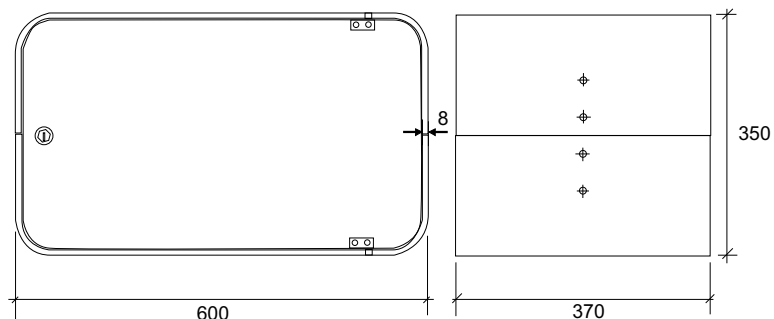

CODE	DESCRIPTION	DIMENSIONS LxLxH mm	WEIGHT kg	MATERIAL	COLOUR
FLBX60TR	Cabinet con serratura Lockable cabinet	600 x 370 x 350	8,60	PMMA	Tutto Trasparente/ All transparent
FLBX60WF			8,60	PMMA	Tutto Satinato/ All frosted
FLBX60PT			8,60	PMMA	Scocca e fondalino satinati, porta trasparente/ Frosted body and back panel, transparent door
FLBX60PS			8,60	PMMA	Scocca e porta satinati, fondalino trasparente/ Frosted body and door, transparent back panel
FLBX60TT			8,60	PMMA	Scocca satinata, porta e fondalino trasparenti/ Frosted body, transparent back panel and door

● INSTALLAZIONE / INSTALLATION

Per poter installare i cabinet cod FLBX60 sui tubi verticali è necessario utilizzare gli appositi attacchi. Tali attacchi possono essere di due tipi, a seconda che essi debbano essere installati in modo "indipendente" (sfalsati) o "in parallelo".

In order to install the cabinets code FLBX60 on the vertical poles, you will need specific clamping.

Clamps come in two different models, depending on which kind of installation you are going to choose: "independent" installation or "parallel" installation.

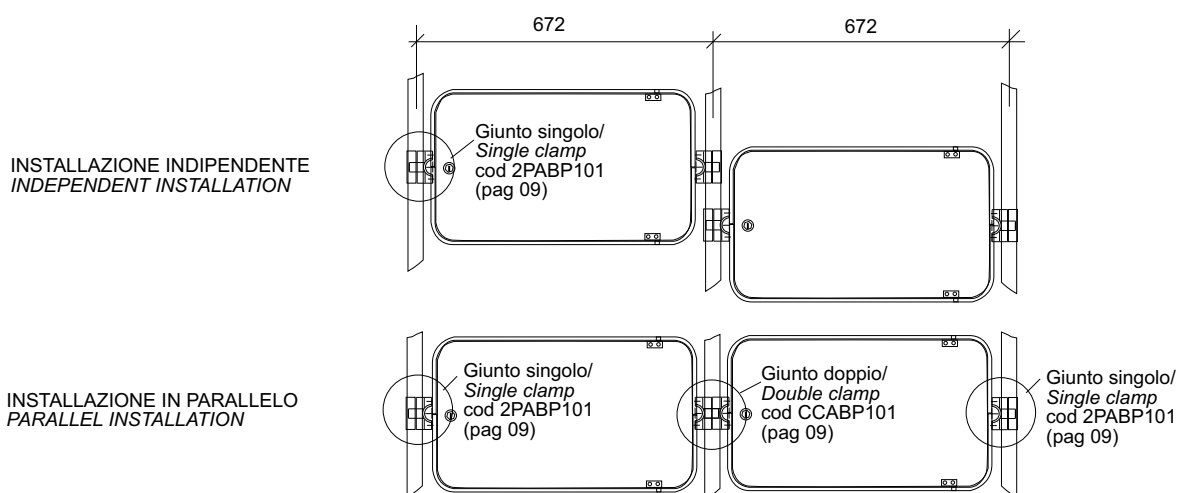

ATTENZIONE: Nel caso di installazione "in parallelo", sarà necessario utilizzare, all'inizio e alla fine della serie, un giunto "singolo" cod 2PABP101, mentre su tutti i montanti intermedi verranno utilizzati giunti "doppi" cod CCABP101

IMPORTANT NOTE: When making a "parallel" installation, you will always need, at the beginning /at the and of the series, a "single" clamp code 2PABP101, while on all the middle poles you will use the "double" clamps code CCABP101

PANNELLO OTTICA / PANEL FOR EYEGLASSES

cod. OT61PM-- / Code OT61PM--

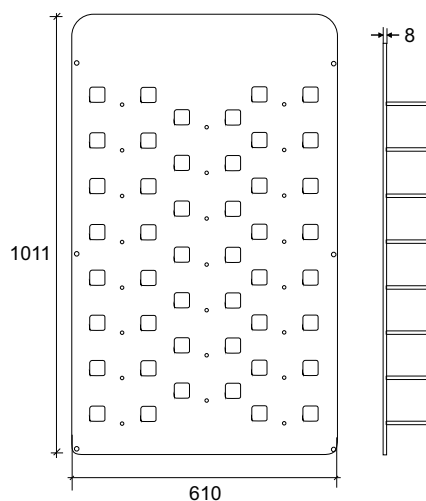

CODE	DESCRIPTION	DIMENSIONS LxLxH mm	WEIGHT kg	MATERIAL	COLOUR
OT61PMTR	Pannello in acrilico per occhiali. Elementi per fissaggio ai tubi verticali: inclusi. Porta fino a 23 paia di occhiali/ <i>Acrylic panel for eyeglasses/sunglasses. Fixing elements to vertical poles: included. Can support up to 23 pairs of glasses.</i>	610 x 8 x 1011	6,50	PMMA	Trasparente/ <i>Transparent</i>
OT61PMWT	Bianco monosatinato/ <i>White, one side frosted</i>				

● INSTALLAZIONE / INSTALLATION

Il pannello cod. OT61PM-- è completo di attacchi per fissaggio ai montanti verticali
Panel code OT61PM-- already includes fixing elements to vertical poles

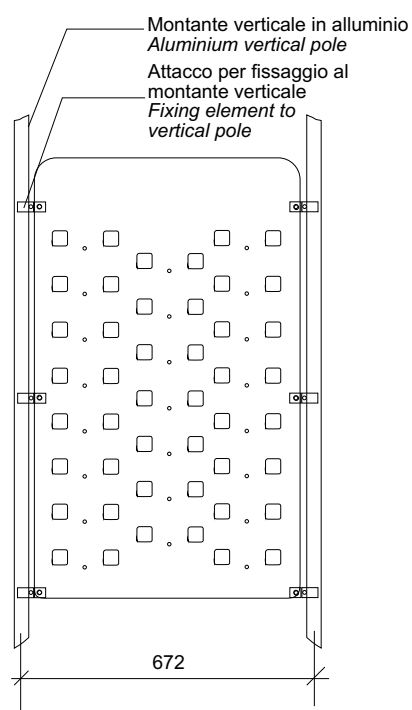

SUPPORTI PER RIPIANI e PANNELLI / SUPPORTING ELEMENTS FOR SHELVES and PANELS

cod. 2PABP101 / Code 2PABP101

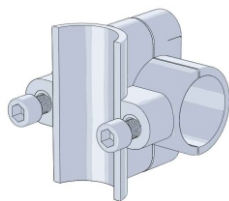

CODE	DESCRIPTION	DIMENSIONS LxLxH mm	WEIGHT kg	MATERIAL	COLOUR
2PABP101	Giunto singolo per cod. CRPM60/FLBX60 / Single clamp for codes CRPM60/FLBX60	56 x 76 x 76	0,169	Polycarbonato/ Polycarbonate	Trasparente/ Transparent

● INSTALLAZIONE / INSTALLATION

Gli attacchi cod 2PABP101 sono necessari per poter installare le mensole cod. CRPM60-- (pag.01) e i cabinet cod. FLBX60-- (pag. 07)
You will need clamps code 2PABP101 to install shelves code CRPM60-- (see page 01) and cabinets code FLBX60-- (see page 07)

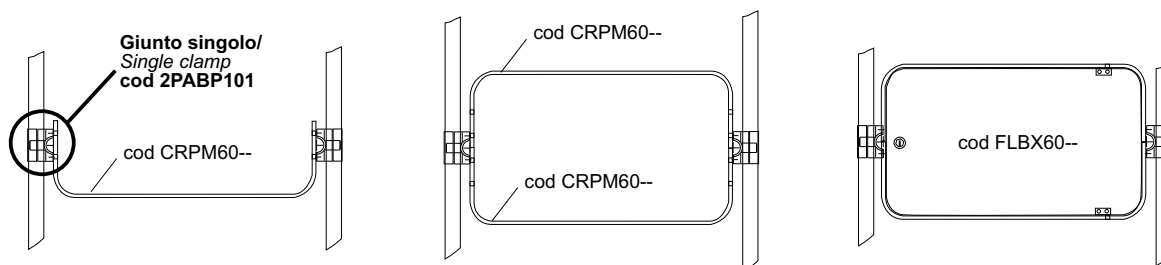

cod. CCABP101 / Code CCABP101

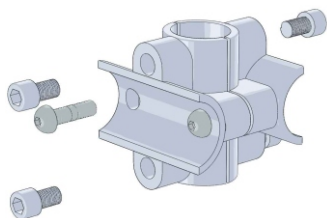

CODE	DESCRIPTION	DIMENSIONS LxLxH mm	WEIGHT kg	MATERIAL	COLOUR
CCABP101	Giunto doppio per cod. CRPM60/FLBX60 / Double clamp for codes CRPM60/FLBX60	76 x 72 x 76	0,169	Polycarbonato/ Polycarbonate	Trasparente/ Transparent

● INSTALLAZIONE / INSTALLATION

Gli attacchi cod CCABP101 sono necessari per poter installare "in parallelo" le mensole cod. CRPM60--(vedi pag.01) e i cabinet cod. FLBX60--(vedi pag. 07).
You will need clamps code CCABP101 to make "parallel" installation of shelves code CRPM60-- (see page 01) or cabinets code FLBX60--(see page 07)

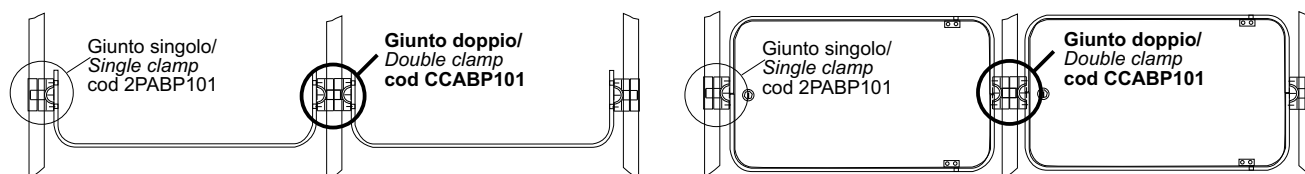

ATTENZIONE: Anche nel caso di installazione "in parallelo", sarà necessario utilizzare, all'inizio e alla fine della serie, un giunto "singolo" cod 2PABP101, mentre su tutti i montanti intermedi verranno utilizzati giunti "doppi" cod CCABP101
IMPORTANT NOTE: When making a "parallel" installation, you will always need, at the beginning /at the end of the series, a "single" clamp code 2PABP101, while on all the middle poles you will use the "double" clamps code CCABP101

SUPPORTI PER RIPIANI e PANNELLI / SUPPORTING ELEMENTS FOR SHELVES and PANELS

cod. DBMRP101 / Code DBMRP101

CODE	DESCRIPTION	DIMENSIONS LxLxH mm	WEIGHT kg	MATERIAL	COLOUR
DBMRP101	Supporto per ripiano orizzontale, completo di N°3 ventose d'appoggio/Supporting element for horizontal shelf, n° 3 suction cups included	116 x 214 x 25	0,20	Policarbonato/ Acciaio al carbonio Polycarbonate /Carbon steel	Trasparente/ Alluminio satinato Transparent/ Glazed aluminium

● INSTALLAZIONE / INSTALLATION

I supporti cod DBMRP101 sono necessari per poter installare le mensole orizzontali cod. RPPM62-- (vedi pag.03) e sono forniti completi di N°3 ventosine trasparenti. Nel caso in cui venga installato un ripiano forabile, è possibile utilizzare , al posto delle ventose, delle viti. You will need elements code DBMRP101 to install horizontal shelves code RPPM62-- (see page 03). Code DBMRP101 includes, as a standard, N°3 transparent suction cups. In case you are going to install a pierceable shelf, you can use N°3 screws, in place of the suction cups.

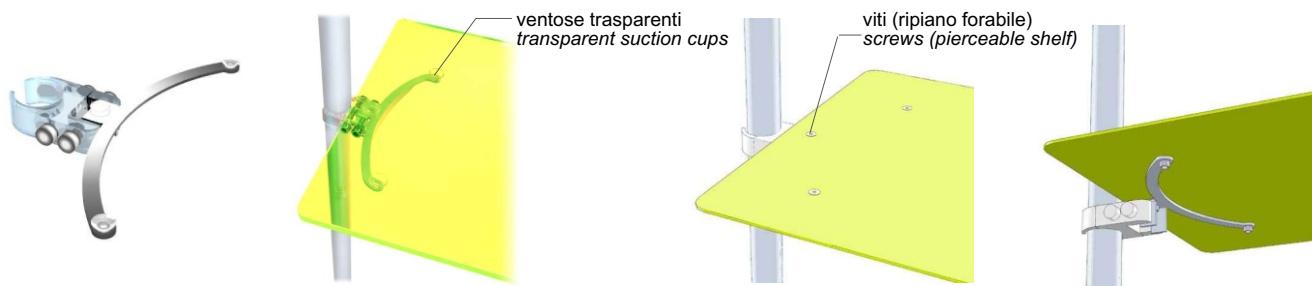

cod. MRSP101 / Code MRSP101

CODE	DESCRIPTION	DIMENSIONS LxLxH mm	WEIGHT kg	MATERIAL	COLOUR
MRSP101	Supporto per pannello rigido, completo di 2 viti e 2 ventose trasparenti/Supporting element for rigid panel, 2 screws and 2 transparent suction cups included	22 x 45 x 69	0,10	Policarbonato/ Polycarbonate	Trasparente/Transparent

● INSTALLAZIONE / INSTALLATION

L'elemento cod MRSP101 permette di installare pannelli aventi spessore da 1 a 30 mm. Nel sistema Fluo il pannello viene installato tra due montanti verticali posti ad una distanza fissa, ragion per cui il pannello dovrà avere una larghezza obbligatoria di 584 mm (l'altezza del pannello è invece variabile a piacimento) / Item code MRSP101 allows you to install rigid panels having thickness ranging from 1 up to 30 mm. Being the distance between the two vertical uprights fixed, panel must have 584 mm width (while height is up to your choice).

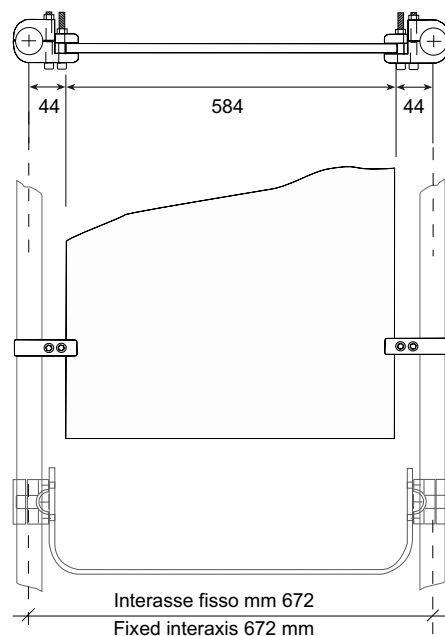
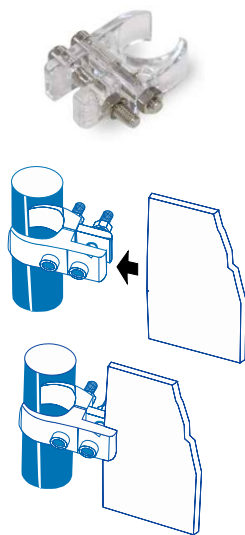

MONTANTI VERTICALI / VERTICAL POLES

INSTALLAZIONE PAVIMENTO/SOFFITTO / FLOOR-TO-CEILING INSTALLATION

cod. TBEXALX-- / Code TBEXALX--

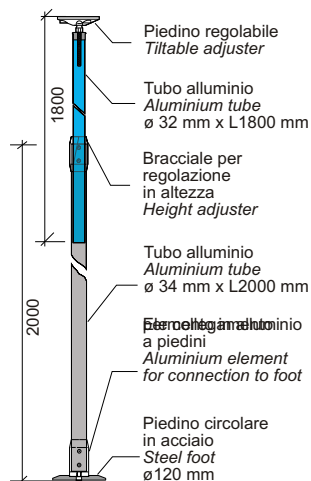

CODE	DESCRIPTION	DIMENS. LxLxH mm	WEIGHT kg	MATERIAL	COLOUR
TBEXALX200	Montante verticale estensibile da 2075 a 3700 mm <i>Extensible vertical pole. Extension range: 2075-3700 mm</i>	ø34	3,70	Alluminio+ Acciaio+Nylon/ Aluminium+ Steel+Nylon	Alluminio satinato/ Glazed Aluminium

cod. TBEXALS-- / Code TBEXALS--

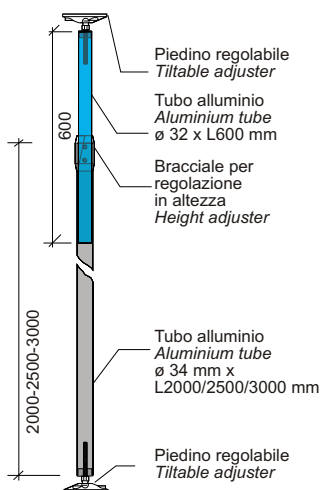

CODE	DESCRIPTION	DIMENS. LxLxH mm	WEIGHT kg	MATERIAL	COLOUR
TBEXALS200	Montante verticale estensibile da 2095 a 2600 mm <i>Extensible vertical pole. Extension range: 2095-2600 mm</i>	ø34	1,45	Alluminio+ Acciaio+Nylon/ Aluminium+ Steel+Nylon	Alluminio satinato/ Glazed Aluminium
TBEXALS250	Montante verticale estensibile da 2595 a 3100 mm <i>Extensible vertical pole. Extension range: 2595-3100 mm</i>	ø34	1,58		
TBEXALS300	Montante verticale estensibile da 3095 a 3600 mm <i>Extensible vertical pole. Extension range: 3095-3600 mm</i>	ø34	1,71		

● INSTALLAZIONE / INSTALLATION



PARTICOLARE DELL' ATTACCO A SOFFITTO/
DETAIL OF UPPER TILTABLE ADJUSTER

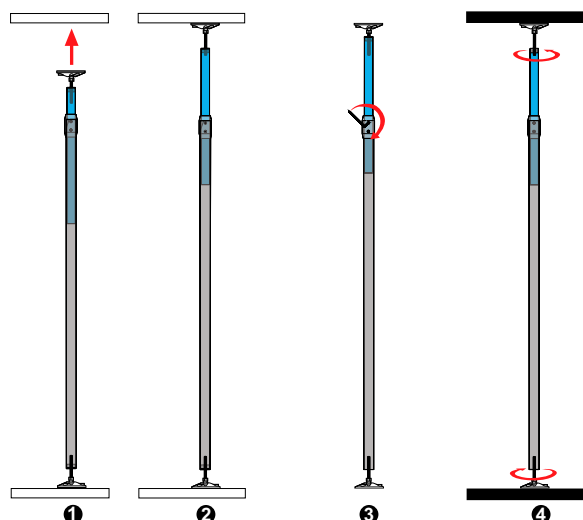

MONTANTI VERTICALI / VERTICAL POLES

INSTALLAZIONE AUTOPORTANTE / SELF-STANDING INSTALLATION:

cod. PLBCC-- / Code PLBCC--

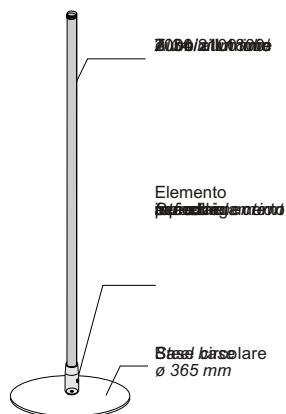

CODE	DESCRIPTION	DIMENS. LxLxH mm	WEIGHT kg	MATERIAL	COLOUR
PLBCC180	Set composto da tubo verticale e braccetti per fissaggio a parete/ Aluminium set composed of vertical tube w/brackets for wall installation	Ø34 X 1800	9,10	Alluminio+ Acciaio al carbonio/ Aluminium+ Carbon Steel	Alluminio satinato/ Glazed Aluminium
PLBCC200		Ø34 X 2000	9,15		
PLBCC210		Ø34 X 2100	9,18		

INSTALLAZIONE A PARETE / WALL- INSTALLATION:

cod. WLALM-- / Code WLALM--



CODE	DESCRIPTION	DIMENS. LxLxH mm	WEIGHT kg	MATERIAL	COLOUR
WLALM200	Set composto da tubo verticale con piedino Ø120 mm e braccetti per fissaggio a parete/ Aluminium set composed of vertical tube w/Ø120 mm round feet + arms for wall installation	Ø34 X 2000	3,14	Alluminio+ Acciaio al carbonio/ Aluminium+ Carbon Steel	Alluminio satinato/ Glazed Aluminium
WLALM210		Ø34 X 2100	3,16		
WLALM250		Ø34 X 2500	3,27		

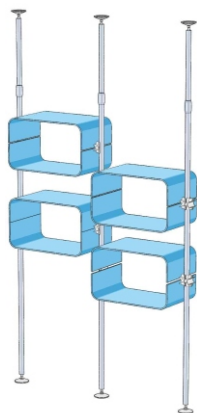

Esempio di utilizzo cod. TBEXALS250/
Example using Cod. TBEXALS250

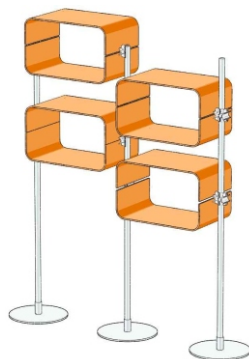

Esempio di utilizzo cod. PLBCC180
Example using Cod. PLBCC180

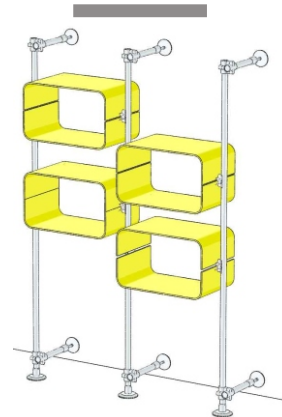

Esempio di utilizzo cod. WLALM210
Example using Cod. WLALM210

ELEMENTI APPENDERIA / HANGING ELEMENTS

cod. APPC60TR / Code APPC60TR

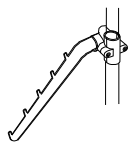

CODE	DESCRIPTION	DIMENSIONS LxLxH mm	WEIGHT kg	MATERIAL	COLOUR
APPC60TR	Appenderia trasparente "a sbalzo", completa di attacco per fissaggio su montante verticale/ <i>Transparent waterfall arm, fixing element for vertical pole included</i>	400 x 40 x 8	0,34	PMMA	Trasparente/ <i>Transparent</i>

cod. APP----A1 / code APP----A1
cod. APP----PM / code APP----PM

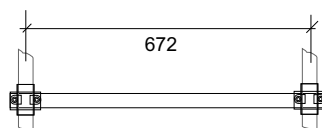
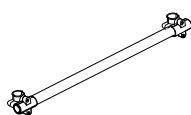

CODE	DESCRIPTION	DIMENSIONS LxLxH mm	WEIGHT kg	MATERIAL	COLOUR
APP075A1	Modulo appenderia , completo di attacchi per fissaggio su montanti verticali/ <i>Horizontal hanging tube, fixing elements to vertical poles included</i>	ø 34 x 750 mm	0,63	Alluminio / <i>Aluminium</i>	Alluminio satinato/ <i>Glazed aluminium</i>
APP075PM			1,24	PMMA	Trasparente/ <i>Transparent</i>

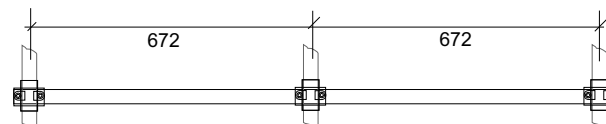
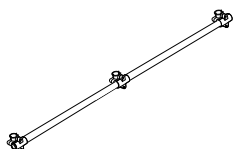

CODE	DESCRIPTION	DIMENSIONS LxLxH mm	WEIGHT kg	MATERIAL	COLOUR
APP143A1	Modulo appenderia , completo di attacchi per fissaggio su montanti verticali/ <i>Horizontal hanging tube, fixing elements to vertical poles included</i>	ø 34 x 1430 mm	1,03	Alluminio / <i>Aluminium</i>	Alluminio satinato/ <i>Glazed aluminium</i>
APP143PM			2,18	PMMA	Trasparente/ <i>Transparent</i>

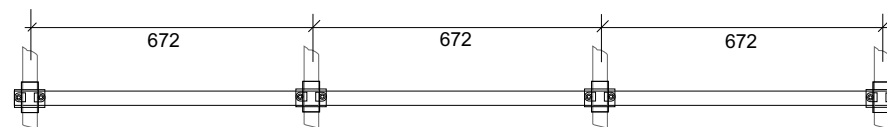
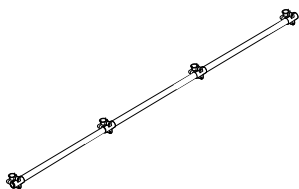

CODE	DESCRIPTION	DIMENSIONS LxLxH mm	WEIGHT kg	MATERIAL	COLOUR
APP210A1	Modulo appenderia , completo di attacchi per fissaggio su montanti verticali/ <i>Horizontal hanging tube, fixing elements to vertical poles included</i>	ø 34 x 2100 mm	1,43	Alluminio / <i>Aluminium</i>	Alluminio satinato/ <i>Glazed aluminium</i>
APP210PM			3,12	PMMA	Trasparente/ <i>Transparent</i>

ILLUMINAZIONE / LIGHTING

cod. ACL50C- / Code ACL50C-

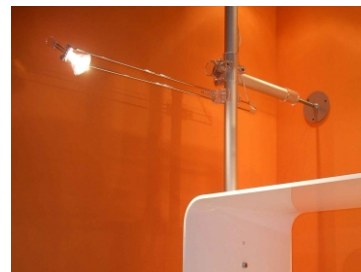

CODE	DESCRIPTION	DIMENSIONS LxLxH mm	WEIGHT kg	MATERIAL	COLOUR
ACL50CM	Lampada dicroica, con lampadina 50W e cavo L=3 mt / <i>Dichroic lamp 50W + 3 mt cord</i>	45x50x600	0,45	Policarbonato+Acciaio/ <i>Polycarbonate+Steel</i>	Trasparente+Cromato/ <i>Transparent+Chrome</i>
ACL50CT	Lampada dicroica, con lampadina 50W, cavo L=3 mt, trasformatore elettronico / <i>Dichroic lamp 50W + 3 mt cord + electronic transformer</i>	45x50x600	0,80	Policarbonato+Acciaio/ <i>Polycarbonate+Steel</i>	Trasparente+Cromato/ <i>Transparent+Chrome</i>

cod. LDF2W4C + cod. TRLD9W / Code LDF2W4C + cod. TRLD9W

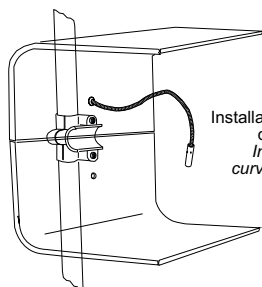

Installazione all'interno
di mensole Fluo/
*Installation inside
curved Fluor shelves*

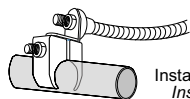

Installazione su tubo/
Installation on tube

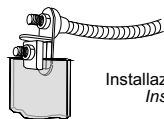

Installazione su pannello/
Installation on panel

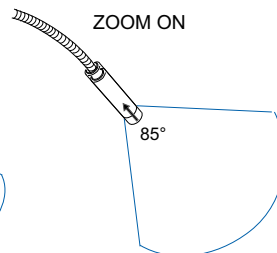
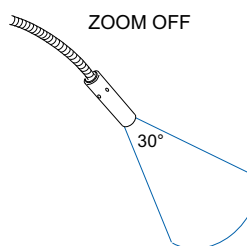
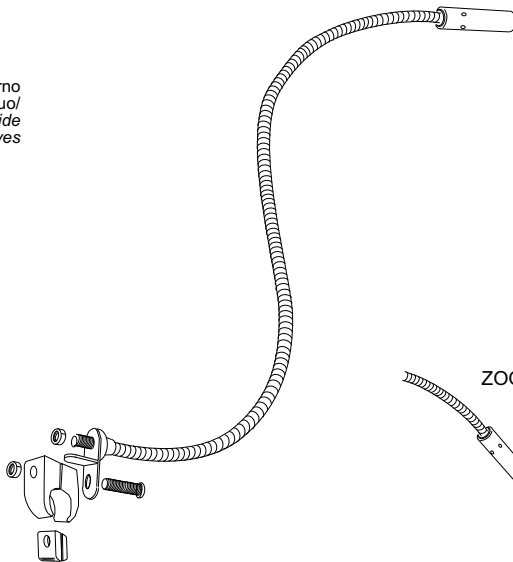

CODE	DESCRIPTION	DIMENSIONS LxLxH mm	WEIGHT kg	MATERIAL	COLOUR
LDF2W4C	Lampada LED (2 W) adatta all'installazione all'interno di mensole curve Fluo. Stelo completamente flessibile. Zoom 30°-85° Completa di doppio attacco: a pannello sp.1-30 mm/ a tubo ø34 mm. Cavo trasparente 3 mt incluso. Trasformatore escluso. <i>LED lamp (2 W) suitable to installation inside curved Fluor shelves. Completely flexible arm. Zoom 30°-85°. Double fixing system: to panel (1-30 mm th.) / to ø34mm tube. Transparent 3 mt cable included. Transformer NOT included.</i>	400 x ø 7	0,30	Acciaio/Steel	Cromato/ <i>Chromium-plated</i>
TRLD9W	Trasformatore per alimentare da 1 a 4 lampade LED cod. LDF2W4C. Morsetti 220V e 12V inclusa. Cablaggio escluso. <i>Transformer for LED lamps code LDF2W4C. Can feed up to 4 lamps. Wiring NOT included. 220V/12V terminal board included.</i>	115X35X20	0,10	Plastica/Plastic	Bianco/ <i>White</i>

ESEMPI / EXAMPLES

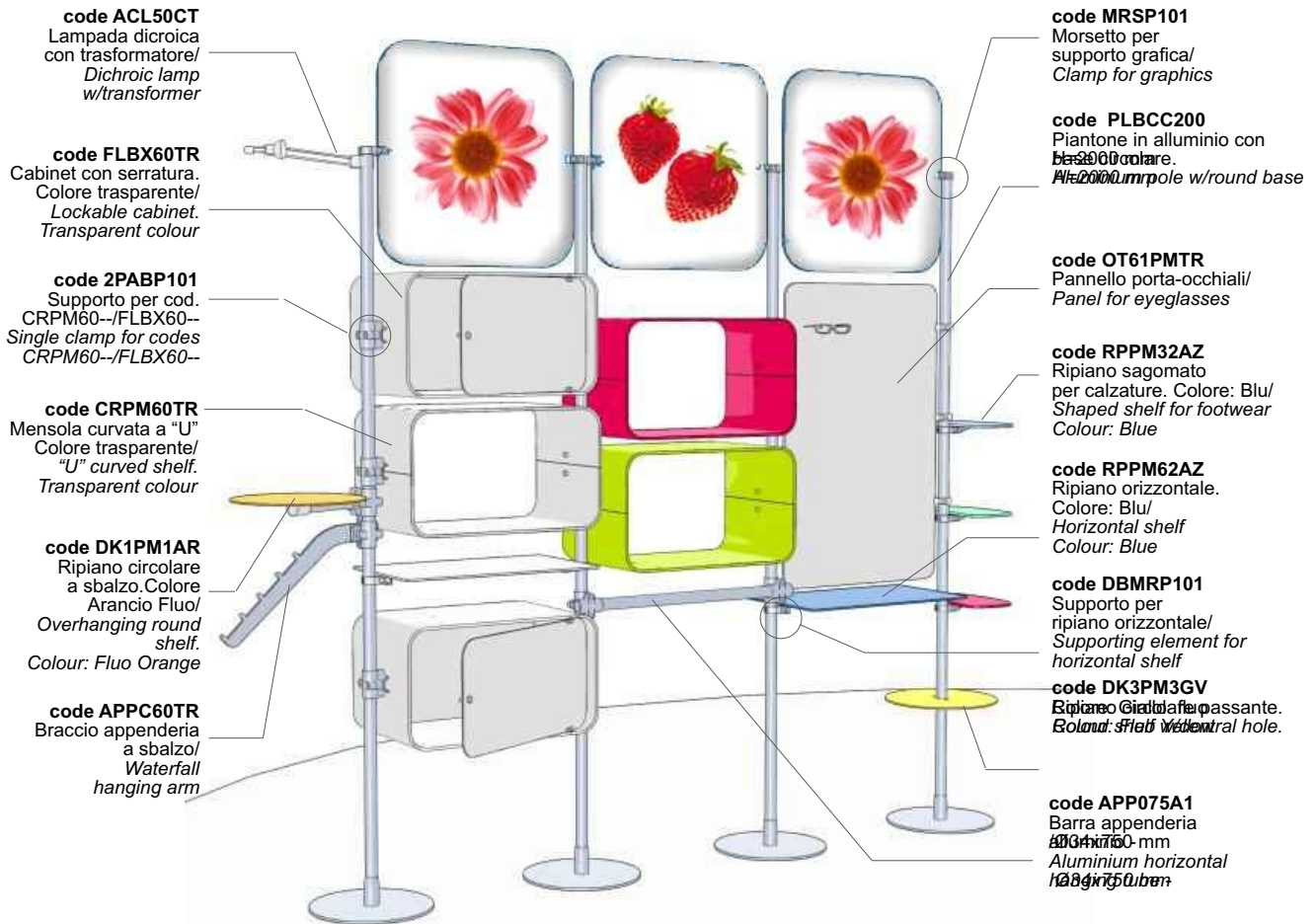

Code	Descrittore/	N°
FLBX60TR	Cabinet con serratura. Colore trasparente /	2
CRPM60GV	Mensola curvata a sbalzo "U". Colore: Giallo fluo /	2
CRPM60RD	Mensola curvata a sbalzo "U". Colore: Rosso fluo /	2
CRPM60TR	Mensola curvata a sbalzo "U". Colore: Trasparente /	2
2PABP101	Supporto per elementi curvati, sito di fissaggio incluso	10
PLBCC200	Piantone in alluminio Ø34 x 2000 (2000) with, comb base circolare /	4
ACL50CT	Lampada dicroica con corda 3m + trasformatore elettronico	1
RPPM62BI	Ripiano orizzontale. Colore: Bianco /	1
RPPM62AZ	Ripiano orizzontale. Colore: Blu /	1
DBMRP101	Supporto per ripiano orizzontale / supporto di fissaggio	4
APPC60TR	Braccio appenderia a sbalzo "a cascata" /	1
APP075A1	Barra appenderia in alluminio Ø34 x 750 mm /	1
RPPM32AZ	Ripiano sagomato con attacco trasparente. Colore: Blu / Shaped shelf, with transparent fixing element. Colour: Blue	1
RPPM32VD	Ripiano sagomato con attacco trasp. Colore: Verde Acquamarina / Shaped shelf, with transparent fixing element. Colour: Green Aquamarine	1
RPPM32RD	Ripiano sagomato con attacco trasparente. Colore: Rosso Fluo / Shaped shelf, with transparent fixing element. Colour: Red	1
OT61PMTR	Pannello porta-occhiali / porta-occhiali / glasses holder / glasses	1
DK1PM1AR	Ripiano a sbalzo. Colore: Arancio fluo / Overhanging	1
DK3PM3GV	Ripiano circolare a sbalzo con foro centrale. Colore: Giallo fluo /	1
MRSP101	Supporto per fissaggio pannelli (2000mm x 800mm) /	6

www.leonardosrl.com

